



Eurotec Finishing Systems Limited
Unit 4 Lockflight Buildings, Wheatlea Industrial Estate,
Wigan WN3 6XR
Phone: 01942 829 111 Fax: 01942 820 491
<http://www.exel-uk.com> e-mail : enquiries@exel-uk.com

SYSTEM CONTROL UNIT SCU 400

INSTRUCTION MANUAL

DOCUMENT:	System Control Unit - <i>Manual</i>
DATE ISSUED:	1 April, 2004
ISSUE NUMBER:	1

CAUTION

This equipment can be dangerous unless it is used in accordance with the rules laid down in this manual.

Read this manual completely before installing and operating the equipment.

Ensure all safety instructions and procedures are correctly followed and that all operators are fully trained.

IMPORTANT: *All other manuals relevant to components and equipment of the installation must be followed.*

CONTENTS

- 1. Title**
- 2. Caution**
- 3. Contents**
- 4. Declaration of Conformity**
- 5. System Control Unit**
- 6. Specification, SCU-400**
 - *Weights and Dimensions*
 - *Electrical Data, Electrical Controls*
 - *Pneumatic Data, Pneumatic Controls*
- 7. SCU-400 General Assembly Drawing**
- 8. Front Panel Symbols Explanation**
- 9. Rear Panel Symbols Explanation**
- 10. Parts List**
- 11. Schematic Diagrams**
 - *SCU-400 Pneumatic Diagram*
 - *SCU-400 Wiring Diagram*

EC Declaration Of Conformity

We, Eurotec Finishing Systems Limited declare that the following product,

Description: System Control Unit

Model: SCU-400

Use: Electrostatic Powder Coating System Control Unit

was manufactured by ourselves and conforms with the following standard (s) and /
or other normative document (s):

EC Machinery Directive 89/392/EEC

EC Low Voltage Directive 73/23/EEC

EC Directive of Electromagnetic Compatibility 89/336/EEC

Electrostatic Painting and Finishing Equipment Using Flammable

Materials

EN50 050:1986 and EN50 053:Part 2:1989

Signed on behalf of Eurotec Finishing Systems Ltd. by



Mr. D.H. Campbell
Technical Director

Eurotec Finishing Systems Limited

Unit 4 Lockflight Buildings, Wheatlea Industrial Estate, Wigan, WN3 6XR

Tel: 01942 829111 Fax: 01942 820491

V.A.T. Reg. No. 535 0123 87

Company No. 3008563 Registered In England

SCU-400 SYSTEM CONTROL UNIT

GENERAL DESCRIPTION

Part No. 2026002

The System Control Unit (SCU) provides the master control functions for the powder application equipment of an automatic powder coating system.

It provides for switched distribution of mains electrical supplies to the gun control units. A connector on the rear panel enables the electrical supply to the gun control units to be triggered externally e.g. by photo-detectors across a spray booth to detect the presence or absence of product. Spray guns may therefore be switched on and off together from an external source.

It provides for independently switched mains electrical outputs for running or triggering two gun manipulators/robots e.g. Reciprocators or Swingers.

Two regulated air supplies are available via a solenoid valve and 4 bar (60 psi) pressure regulators and gauges.

The incoming electrical supply is switched through a latching relay, which enables safe interlocking with other parts of a system e.g. extraction systems, conveyors etc. The main switch must be reset manually if the emergency stop is operated or the mains supply is interrupted.

An emergency stop button is provided on the front panel with a facility via a rear panel connector to connect external emergency stop stations. The main switch must be reset manually if the emergency stop is operated.

The main switch and emergency stop button control all spray gun and gun mover functions of the System Control Module and therefore controls all automatic equipment connected to it.

SPECIFICATION

Weights & Dimensions

Nett Weight:-	8 kg.
Nett Dimensions:-	280 x 280 x 118 mm.
Packed Weight:-	8.8 kg.
Packed Dimensions:-	415 x 315 x 160 mm.
Total Packed Volume:-	0.021 cubic metre.

Electrical Data

Input Voltage:-	100-260 Volts, 50/60 Hz, Single Phase.
Input Current:-	Max. 16 amps.
Output Current:-	Switched mains output to gun control modules, <i>6 amps Max</i> 2 independently switched mains outputs to gun manipulators, <i>10 amps Max.</i> (total) Non switched supply to auxillary equipment, <i>2 amps Max.</i>
Remote and Trigger Outputs:-	24 Volts d.c. to remote emergency stop stations. 24 Volts d.c. to remote trigger/sensor contacts.

Electrical Controls

Mains Isolator - Front Panel	Rotary 2 position Switch Off/On/Start (spring return from start to on). Controls mains supply to the SCU .
Mains Output Switch - Front Panel	Illuminated latching push button switch Off/On. Controls the mains electrical supply to the Gun Control Units.
Mains Air Switch - Front Panel	Rotary 2 position Off/On. Controls the incoming mains air supply.
Emergency Stop Button - Front Panel	Switches off all electrical and pneumatic functions.
Manipulator Switch No. 1. - Front Panel	Illuminated latching push button switch Off/On. Controls the mains electrical supply/trigger to a gun manipulator.
Manipulator Switch No. 2. - Front Panel	Illuminated latching push button switch Off/On. Controls the mains electrical supply/trigger to a second gun manipulator.
Circuit Protection - Rear Panel	<i>Miniature circuit breakers:-</i> Mains power supply input <i>0.6A</i> Mains switched output GCU <i>6A</i> Mains robot output <i>10A</i> Mains slave output <i>2A</i>

Mains Input Connector	16A single phase + earth 100-260V 50/60 Hz.
Switched Mains Output Connector - Rear Panel	Switched mains output via. 3pin + earth socket. (Powers gun control units etc.)
Slave Mains Output Connector - Rear Panel	Slave mains output via. 3pin + earth socket (Powers additional control units).
Manipulator 1 & 2 Output Connectors - Rear Panel	2 individual 3pin + earth sockets
Remote trigger Output / E-Stop Connector - Rear Panel	4pin + earth socket 24V dc.(For connection to remote emergency stop stations or remote trigger / sensor contacts).

Pneumatic Data

Input air pressure	7.0 bar (100 p.s.i.) Max.
Input air conditioning	Oil free to 0.1 p.p.m. and dry to 1.3 g/cubic Nm.
Air consumption (Typical)	10.0 cubic m/h. (6.0 c.f.m.) per gun. 10.0 cubic m/h. (6.0 c.f.m.) per fluidised bed.
Input Connection - Rear Panel	8 mm. push in fitting.

Pneumatic Controls

Incoming solenoid valve

Normally closed, opens on operation of main switch to Start position. Controls all regulated and non-regulated outputs.

Pressure regulators and gauges

These control the air supply pressure to the following outputs:-

- 1) *Fluidised Bed No. 1:-* Controls the fluidisation level of a fluidised bed.
- 2) *Fluidised Bed No. 2:-* Controls the fluidisation level of a second fluidised bed, or auxiliary equipment e.g. vibratory sieves or powder transfer units.







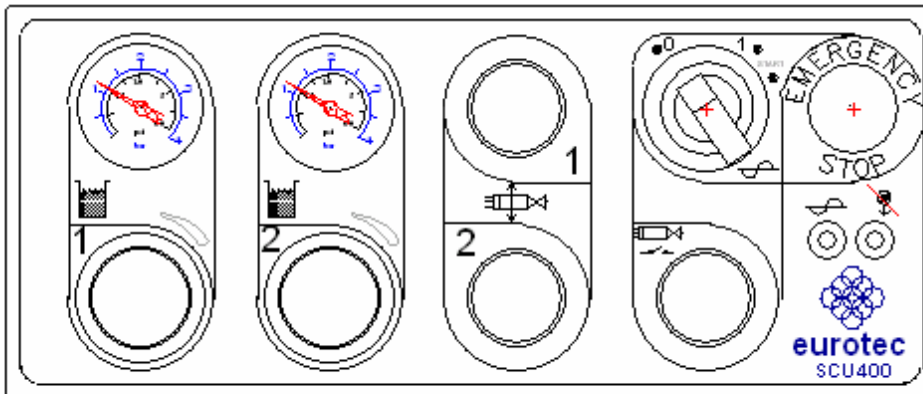

Pneumatic Outputs - Rear Panel

<i>1 non-regulated output (mains air out)</i>	8mm push-in fitting. Slaved from mains input
<i>1 non-regulated output (labeled AUX 1.)</i>	8mm push-in fitting. Controlled by internal solenoid valve. To supply auxiliary equipment such as vibratory sieves or powder transfer units.
<i>2 regulated outputs (labeled FB 1 & 2)</i>	8mm push-in fittings to supply fluidising air to fluid beds.

System Control Unit SCU-400 Front Panel Symbols Eplanation

Illustration 6000235









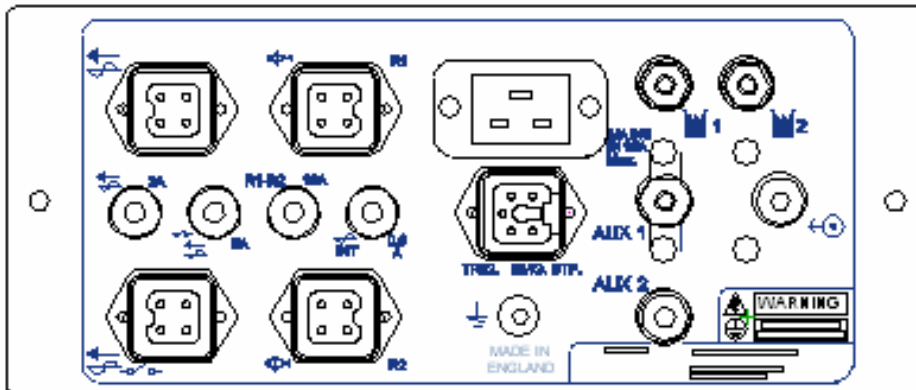









-  1 Regulated Air Supply. Typical Application - Fluid Bed Plenum
-  2 Regulated Air Supply. Typical Application - Fluid Bed Plenum
-  1 On / Off Illuminated Switch For Gun Manipulator eg. Reciprocator
-  2 On / Off Illuminated Switch For Gun Manipulator eg. Reciprocator
-  On / Off Illuminated Switch For Gun Control Units
-  Main On / Off Switch (START - Manual Safety Interlock)
-  Mains Power On Lamp (Manual Start Initiated)
-  Mains Electrical and Air Outputs Disabled Lamp (Manual Start Required)

System Control Unit SCU-400 Rear Panel Symbols Eplanation

Illustration 6000236



-  Mains Electrical Input Connector
-  Mains Electrical Slave Output Connector
-  Mains Electrical Switched Output Connector (To Gun Control Units)
-  Mains Electrical Switched Output Connector (To Gun Manipulator)
-  Mains Electrical Switched Output Connector (To Gun Manipulator)
-  TRIG. EMER. STOP. Electrical Connector For Remote Trigger And Emergency Stop
-  2A Circuit Breaker For Slave Output
-  6A Circuit Breaker For Gun Control Unit Output
-  10A Circuit Breaker For Gun Manipulator Output
-  0.6A Circuit Breaker For Internal Power Supply
-  Earth Post
-  Mains Air Input Connection
-  1 Regulated Air Output Connection (To Fluid bed)
-  2 Regulated Air Output Connection (To Fluid bed)
-  ALIX 1 Non-Regulated Air Output Connection (For Auxiliary Functions)
-  ALIX 2 Non-Regulated Air Output Connection (For Auxiliary Functions)

System Control Unit SCU-400 General Assembly

Part No. 2021002

Illustration 6000237

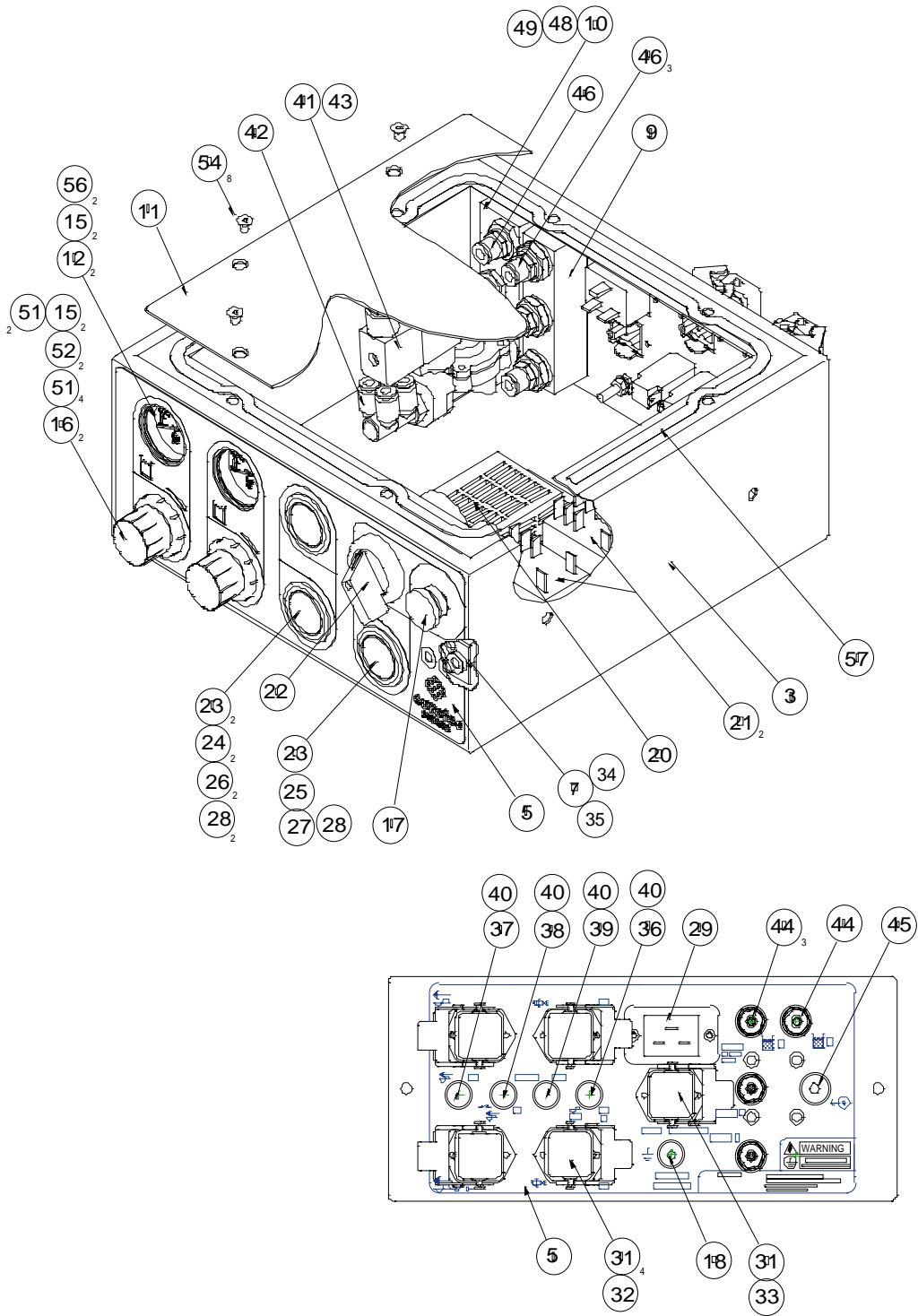

SCU-400 General Assembly*PARTS LIST*

Item	Part No.	Description	Qty
1	2026007	Cableform Mains	1
2	2026008	Cableform L.V.	1
3	2026010	Control Box Detail	1
4	2026012	Front Overlay, SCU400	1
5	2026013	Rear Overlay, SCU400	1
6	2026014	Internal Chassi	1
7	2026015	LED Mounting Plate	1
8	2026016	Gauge Support Plate	1
9	2000018	Manifold Outlet Block	1
10	2000019	Manifold Inlet Block	1
11	2024011	Cover Detail	1
12	2024020	0-4 Bar Pressure Gauge	2
13			
14	5000040	Disc Porous Plastic 8 x 4.75	2
15	5000050	Disc Porous Plastic 8 x 3.2	2
16	9000112	Regulator 4 Bar	2
17	9000155	Switch, Push Button Red	1
18	9000021	Earth Terminal	1
19	2024026	Connector Dust Cover	5
20	9001908	Power Supply 24V dc	1
21	9001909	Relay 2P CO 24V dc	2
22	9001899	Switch, Rotary, 2P 3Posn. Spring Ret.- OFF	1
23	9001900	Switch push Button Actuator, Flush	3
24	9001901	Switch Block, 2P NO	2
25	9001902	Switch Block, 1P NO	1
26	9001903	Switch Screen, Blue	2
27	9001904	Switch Screen, Green	1
28	9001905	Bulb 28V Filament	3
29	9001906	Connector, Panel Mount Plug 16A	1
30	9001907	Connector, Cable Mount Socket	1
31	9000120	Connector, Base Panel Mount	5
32	9000012	Connector Socket Insert, 3 Pin + E	4
33	9000013	Connector Socket Insert, 4 Pin + E	1
34	9001922	Led Green 24V dc	1
35	9001923	Led Red 24V dc	1
36	9000016	Circuit Breaker, 0.6A	1

Continued:-

Item	Part No.	Description	Qty
37	9000017	Circuit Breaker, 2A	1
38	9000018	Circuit Breaker, 6A	1
39	9000103	Circuit Breaker, 10A	1
40	9000019A	Circuit Breaker Boot	4
41	9000038	Valve, solenoid, 2-2 3/8 BSP 24V	1
42	9001901	Banjo Quad, 3/8 BSPMT – 8mm PI	1
43	9000032	Straight, 1/4 BSPMT – 3/8 BSPMT	1
44	9001924	Straight, 1/8 BSPMT – 8mm PI	4
45	9000030	Straight, 1/4 BSPMT – 8mm PI	1
46	9001925	Straight, 3/8 BSPMT – 8mm PI	4
47	9000034	Blank 1/4 BSPMT Hex Skt	1
48	9001880	Blank 1/4 BSPMP Hex Skt	1
49	9001874	Blank 1/4 BSPMT Hex Skt	1
50	9000052	Straight, 1/8 BSPFP – 4mm PI	2
51	9001758	Elbow, 1/4 BSP – 8mm PI	4
52	9000062	Elbow, 1/8 BSP – 4mm PI	2
53	2024015	Seal Ring	2
54	9000600	Screw, M5 x 6 Skt Csk Hd	8
55			
56			
57	9001322	Seal Strip, Form, Self Adhesive, 6 x 3mm	1 M
58			
59			
60			

System Control Unit SCU-400
Pneumatic Diagram
Illustration No. 6000238

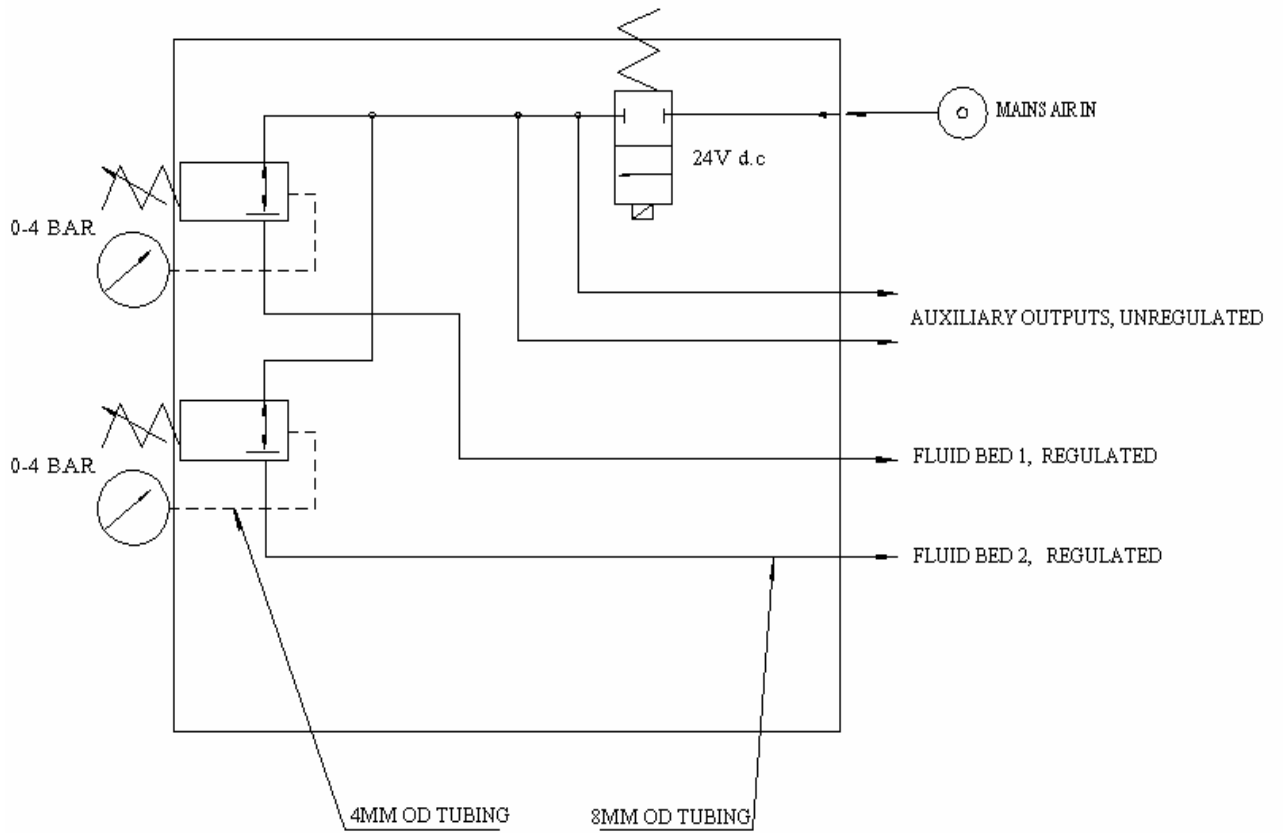

System Control Unit SCU-400

Wiring Diagram

Illustration 6000244

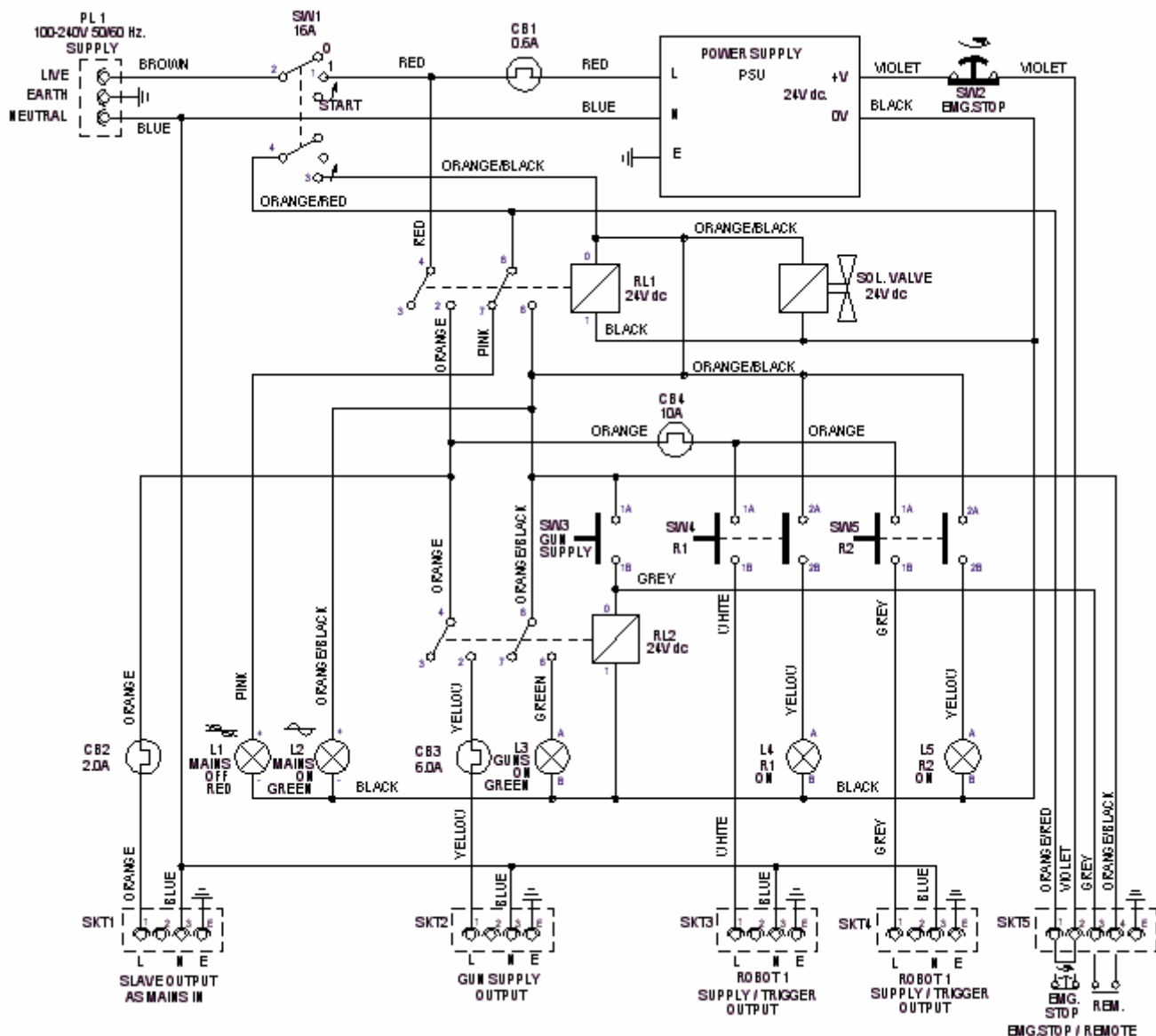

NOTES: